

Patrone Recessed Ceiling Light

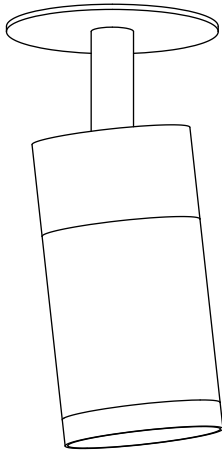

Manual

We hope you will enjoy your new Patrone Lighting and follow these instructions to ensure correct installation.

For any questions contact us at: info@thorupcph.com

Please read these instructions carefully to ensure that the product is used in accordance with its intended purpose only. For installation we advise you to consult a professionally qualified electrician.

Thorup Cph is not responsible for any faults or damages caused by not following these instructions correctly. Do not modify this lamp in any way.

Each lamp is locally crafted in Copenhagen, by skilled artisans. Due to the hand-made process, each product is unique, and variations may occur.

LED GU10 - Max 4 Watts

Compatible with bulbs of energy classes A++

For indoor use only

Content

- Ceiling lamp fitted with coverplate and two position cable junction box copper tube
- Mounting box with two extendible hanger bars
- White gloves (Wear when installing the brass and nickel-plated brass version, to avoid dark marks on the product).

Tools needed

- Bulb Type: LED GU10

Safety Instructions

- Please read the instructions carefully before commencing assembly.
- Installation should be carried out in accordance with local safety regulations.
- Do not change the lightbulb while the fixture is switched on.
- The lamp is intended for indoor interior use only.
- In order to prevent damage, please check walls for cables before drilling holes.

Mounting

Semi-recessed. Mounting box with two extendible hanger bars to be installed to ceiling cut-out of D: 55 mm.

Maximum diameter of Cut-Out: 58 mm.

Materials

Brass is an honest material with an innate character, that will naturally patina and improve with time. The material will instantly oxidize when exposed to air, humidity and other external stimuli and brass discoloration will occur. This is not a flaw but should be considered as unique features of the material.

Following a hand-made process that enhances each surface with a refined finish, variations in the products may occur, making each lamp unique.

Care & Maintenance

This product is made from solid brass. For regular cleaning, use a soft, dry cloth without loose fibres. Do not use a sponge, polishing creams and/or cloths, chemical or abrasive cleaners and avoid using water. To retain the bright finish or remove dark stains from the raw brass surface, we recommend using our Brass Care Kit. More info about product care visit: thorupcopenhagen.com



INSTALLATION

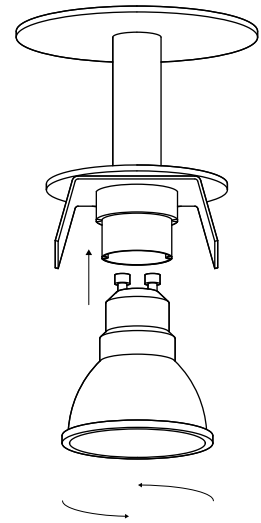
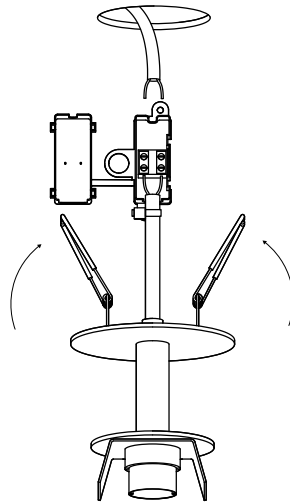
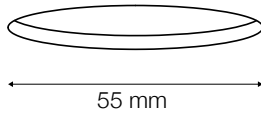

Step 1

Drill the Cut-Out hole of 55 mm for each spot in the ceiling. (maximum diameter of Cut-Out: 58 mm).

Step 2

Insert the recessed lights by pulling the wire into the light's junction box and make the connections. Secure it into place with the clip-hangers that attaches to the inside top of the ceiling.

Step 3

Install the LED bulb firmly by pushing it upwards and carefully turn clockwise until it is fixed in place.

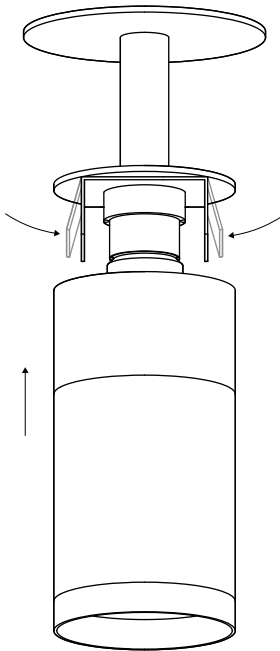

Step 4

Install the shade, by gently pressing the two sides inwards to enclose the insert with the fixture. Use the flexible and rotational neck to set the shade at a desired angle.

Adjustment options

Use the tiltable and rotational neck to set the shade at a desired angle.

Rotation angle: 0-350°

Tilt angle: 0-65°

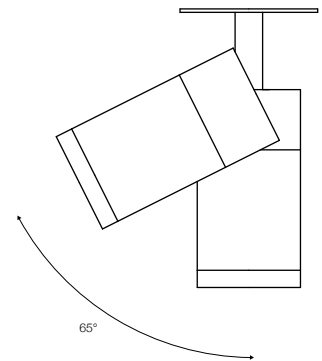
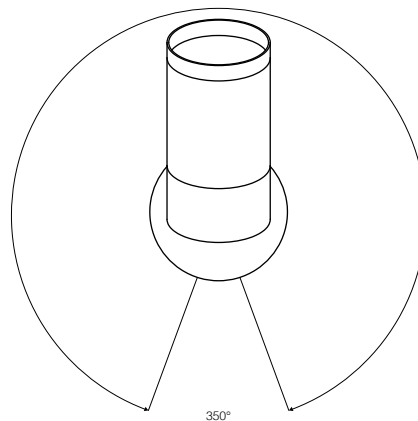

THORUP COPENHAGEN